



USER MANUAL

ReliaCELL 10-20

Certified, Ruggedized Cellular Modem

July 2014 – 110128-90021, preliminary

Trademarks

All trademarks both marked and unmarked appearing in this document are the property of their respective owners.

Revision history

Revision	Description	Date
1	Preliminary release	July 2014

Table of Contents



Trademarks	2
Revision history	2
Table of Contents.....	3
Conventions, Warnings, Regulatory	4
Product Overview.....	6
Features	6
The Configuration Process.....	7
Activate the Cellular Plan.....	7
Provision the Modem.....	7
Install Host Computer Drivers	7
Configure OS to Connect to the Network	7
Mechanical	8
Dimensions	8
Mating Connectors	8
<i>PWB Mount.....</i>	<i>8</i>
<i>Panel Mount Cable.....</i>	<i>8</i>
Hardware Specification.....	9
Power.....	9
Environmental	9
Appendix A: Activating a KORE Data Plan	10
Appendix B: Connecting with Windows 7.....	11
Download and Install the Drivers.....	11
Provision the ReliaCELL 10-20	12
Connect the ReliaCELL 10-20 to the Internet	14
<i>Connect the ReliaCELL 10-20 to the PC.....</i>	<i>14</i>
<i>Disconnect Other Network Adapters.....</i>	<i>14</i>
<i>Create a Windows Dial-Up Connection.....</i>	<i>14</i>
<i>Test the ReliaCELL 10-20</i>	<i>14</i>
Disconnect the ReliaCELL 10-20	15
<i>Re-Enable Other Network Adapters.....</i>	<i>15</i>
Appendix C: Connecting with Linux	16
Utilizing the Generic <i>option</i> Driver	16
Provisioning the ReliaCELL 10-20.....	17
Creating a Connection Manager	18
Using GPS	19
Building the Driver	20
Appendix D: ReliaCELL 10-20 Models.....	22
Appendix E: Modem Commands.....	23

Conventions, Warnings, Regulatory

Eurotech has made every effort to ensure the accuracy of this document. However, Eurotech assumes no liability resulting from any error/omission in this document, or from the use of the information contained herein.

Eurotech reserves the right to revise this document or to make changes to its content at any time without any obligation to notify any person of such revision or changes.

Conventions

SYMBOL	MEANING
File > Save	Shorthand for selecting options from menus and dialog boxes in Microsoft Windows. In this example, you would click the File menu, then the Save option.
<AT><Enter>	The < > brackets indicate text to type or keyboard keys to press. In this example, you would type the letters "A" and "T", then you would press the ENTER key.
	<p>WARNING! Information highlighting potential hazards:</p> <ul style="list-style-type: none"> • Personal injury or death could occur. • Damage to the system, connected peripheral devices, or software could occur. <p>Always use appropriate safety precautions. Also ensure that the installation meets all the requirements as set out for the environment that the equipment will be deployed in.</p>
	<p>NOTE These will highlight important features or instructions.</p>

Safety Notices and Warnings

Observe the following safety precautions during all phases of operation, service, and repair of the device.

Failure to comply with these precautions or with specific warnings elsewhere in this manual violates safety standards of design, manufacture, and intended use of the device.

Eurotech assumes no liability for the customer's failure to comply with these requirements.

The safety precautions listed below represent warnings of certain dangers of which Eurotech is aware. You, as the user of the device, should follow these warnings and all other safety precautions necessary for the safe operation of the device in your operating environment.

Do Not Operate in an Explosive Atmosphere



WARNING!
Do not operate the equipment in the presence of flammable gases or fumes. Operation of any electrical equipment in such an environment constitutes a definite safety hazard.

Life Support Policy

**WARNING!**

Users must not use Eurotech products as critical components of life support devices or systems without the express written approval of Eurotech Spa.

Warranty

Contact your local Eurotech Sales Office for detailed warranty terms and conditions.
Refer to the back covers of this manual for full contact details.

RoHS

This device, including all the components, subassemblies and the consumable materials that are an integral part of the product, have been manufactured in compliance with the European directive 2002/95/EC known as the RoHS directive (Restrictions of the use of certain Hazardous Substances). This directive targets the reduction of certain hazardous substances previously used in electrical and electronic equipment (EEE).

Technical Assistance

For technical questions, isolating a problem with your device, and inquiries about repair and return policies, feel free to contact your local Eurotech Technical Support Team.
See the back cover for full contact details.

Product Overview

The ReliaCELL 10-20 is a fully-certified cellular modem built for rugged applications. Its weatherproof enclosure can be mounted to existing installations to add cellular and GPS connectivity to any system.

Features

The following are features available in the ReliaCELL 10-20 product family. See [Appendix D: ReliaCELL 10-20 Models](#) for details about the features available on each model of the ReliaCELL 10-20.

CELLULAR

Global support for the following cellular technologies:

- 2G GSM
- 2.5G 1x RTT
- 3G HSDPA/UMTS/EVDO Rev A

Ready to Deploy: certified and carrier approved

Ruggedized: for commercial and industrial applications

POSITIONING

Monitors positioning satellites from two systems:

- GPS (US)
- Glonass (Russia)

INTERFACES

1x USB Port

- USB2.0 Type A Compatible for Cellular only
- USB3.0 Type A Cellular and Voice Capability

SIM - Dual microSIM, internal & field replaceable

ANTENNAS

Cellular 2 SMA (main and Diversity, if available)

GPS/Glonass SMA (Optional; not on all modules)

CERTIFICATIONS

IP67

PCTRB

FCC/IC/CE

SAE J1455

UL

TELEC

The Configuration Process

There are four basic steps to begin using a ReliaCELL 10-20 modem:

- *Activation* establishes a usage plan with a cellular carrier.
- *Provisioning* connects the modem to the network and establishes the settings for future connections.
- *Driver Installation* sets up the host computer to communicate with the modem.
- *OS Configuration* creates a socket connection from the host computer to the Internet.

Activate the Cellular Plan

Contact your cellular service provider to establish the cellular data plan for your ReliaCELL 10-20. In most cases, you will need to provide the MEID or IMEI of each unit you are setting up.

KORE Telematics is a Eurotech partner that provides 90-day trial data plans that are easy to establish. See the Quick Start Guide and the Appendix for details.

Provision the Modem

Once the cellular plan is in place, you must connect the modem to a cellular network to download the device's phone number and connection details from the host network. This is done by sending a specific AT command to the modem.

See the Appendices for details about how to send the command via the operating system you are using. You will need a host computer on which the appropriate drivers have already been installed.

Install Host Computer Drivers

Each host computer requires USB drivers to recognize the ReliaCELL 10-20. See the Appendices for details about how to install the ReliaCELL 10-20 drivers for your operating system.

Configure OS to Connect to the Network

Once the drivers are installed, connect the ReliaCELL 10-20 to the Internet as follows:

1. Screw the cellular antenna cable onto the CELL SMA connector.
2. (optional) Screw the GPS antenna cable onto the GPS SMA connector.
3. Plug the ReliaCELL 10-20 into the host computer.
You may use a USB extension cable to make the connection.
The LED will blink green.
4. Set up a network connection in the operating system of the host computer.
See the Appendices for operating-system-specific details.

**WARNING!**

Select the tools you use to connect to the Internet with care.
Web browsing can potentially consume monthly M2M data plans in minutes.

Mechanical

The ReliaCELL 10-20 is designed to bolt to a flat surface, connecting electrically into a recessed USB 2.0 socket. The compression gasket creates an IP67 seal with the mating surface.

Dimensions

The following are the physical dimensions in inches and [millimeters].

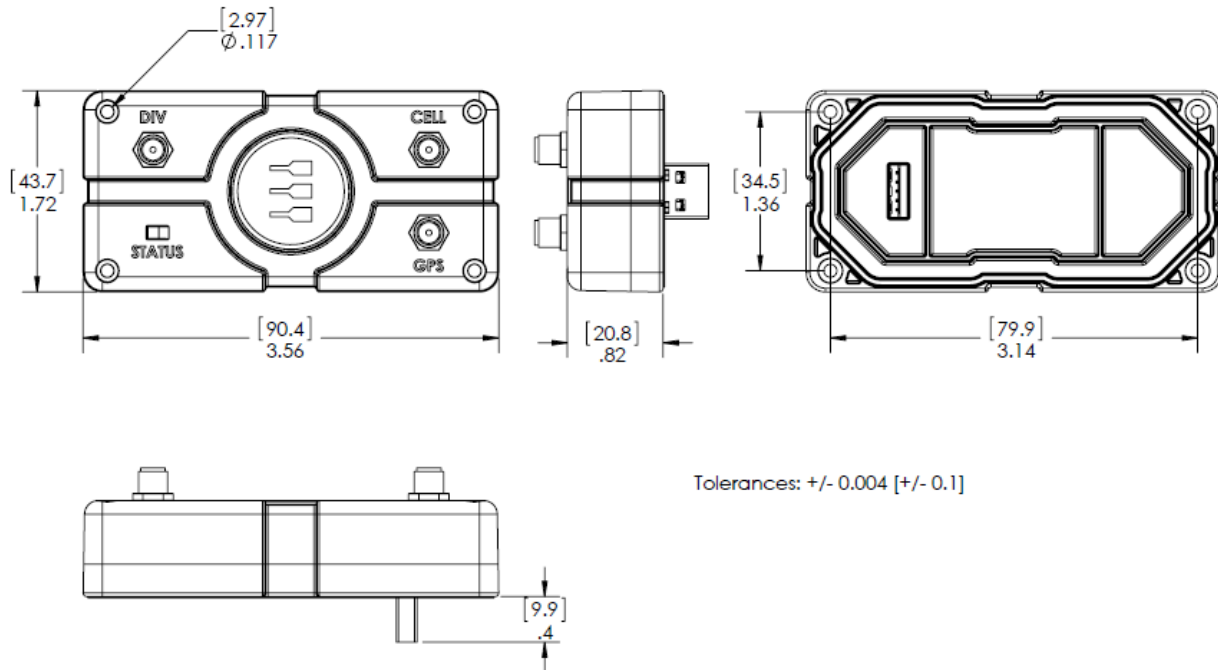

Some models do not include DIV or GPS connectors.

Full mechanical models are available on Eurotech's support site.

Mating Connectors

The ReliaCELL 10-20 can connect to USB 2.0 sockets in a variety of configurations.

PWB Mount

A typical installation will mount a right-angle USB socket on a PWB inside the enclosure. The PWB may be your main board or an adapter board, and is mounted to bring the USB socket flush with the outside of the enclosure.

Panel Mount Cable

If your application requires a panel-mounted cable solution, make sure that the mounting screws or hardware do not extend into the ReliaCELL 10-20 gasket.

The L-com ECJ504B-UA USB jack is one solution, using spacers to provide a flush mount of the socket. The L-com USBAFT Field Termination connector is another suitable product for retrofit applications.

Hardware Specification

Power

The ReliaCELL 10-20 is powered by the host system via the USB port connection.

Symbol	Parameter	Min	Typ.	Max	Units
V_{in}	Input supply voltage		5.0		V
P_{in}	Power consumption	CDMA	2	3	W
		GSM, 2G/3G	1.25	3	W

Environmental

The ReliaCELL 10-20 is designed to meet the environmental specifications listed in the following table.

Parameter	Min	Typ.	Max	Units
Industrial operating temperature	-40		+85	°C
Storage temperature	-40		+85	°C
Relative humidity, non-condensing	5		95	%

Appendix A: Activating a KORE Data Plan

Contact KORE Telematics using the details provided in the Quick Start guide that came with your development kit.

Have the device MEID number handy. The MEID number is printed on the label of the ReliaCELL 10-20.

The KORE representative will walk you through the activation of the cellular service for the modem.

You must have confirmation of this activation before you proceed with the provisioning instructions. The confirmation message may be in the form of an email.

Appendix B: Connecting with Windows 7

The following are instructions for using the ReliaCELL 10-20 on a Windows 7 computer. The drivers also work with Windows Embedded 7 and Windows XP, with slight differences in the installation process.

Download and Install the Drivers

1. Download the drivers for your product from the Eurotech Inc support forums, http://support.eurotech-inc.com/forums/topic.asp?topic_id=3086
Create a forum account if you haven't done so before. Enter the code from the back of your development kit Quick Start guide for access to additional resources.
2. Install the Windows drivers on your PC:
 - a) Log on to your PC with the administrator rights
 - b) Double-click the .EXE installer.
You may need to right-click on the .EXE and select "Run as Administrator".
 - c) When prompted by the Windows Security dialog, check the box next to "Always trust software from "Telit Communications S.p.A." then click "Install".

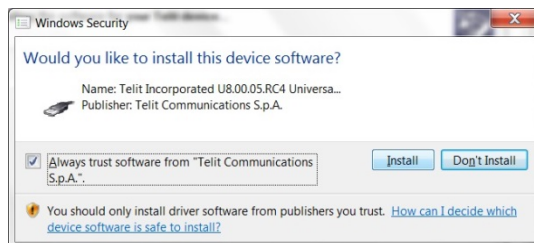

- d) The installer will install three separate drivers. Perform the default installation for each. This process takes about five minutes to complete.

The installer will display a confirmation dialog that your device is ready to use:

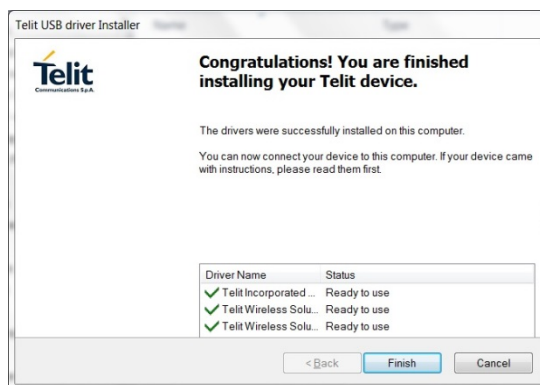

Provision the ReliaCELL 10-20

Note: Before proceeding with this step, you must have confirmation that the MEID has been activated with your carrier

You will need a terminal emulation program. In this guide, we use Teraterm 4.83, which can be downloaded from <http://en.sourceforge.jp/projects/ttssh2/downloads/61280/teraterm-4.83.exe/> To install, run the install file and select “Standard Installation”, then follow the prompts.

1. Using the USB extension cable provided with the development kit, connect the ReliaCELL 10-20 to a Windows 7 PC.
2. Attach the whip antenna provided to the ReliaCELL 10-20 SMA connector marked CELL.
3. Determine the Serial Port used to communicate with the modem.

Select **Start > Control Panel > Device Manager > Ports (COM & LPT)**.

The serial port number will be listed next to the **Telit Auxiliary Port** entry.

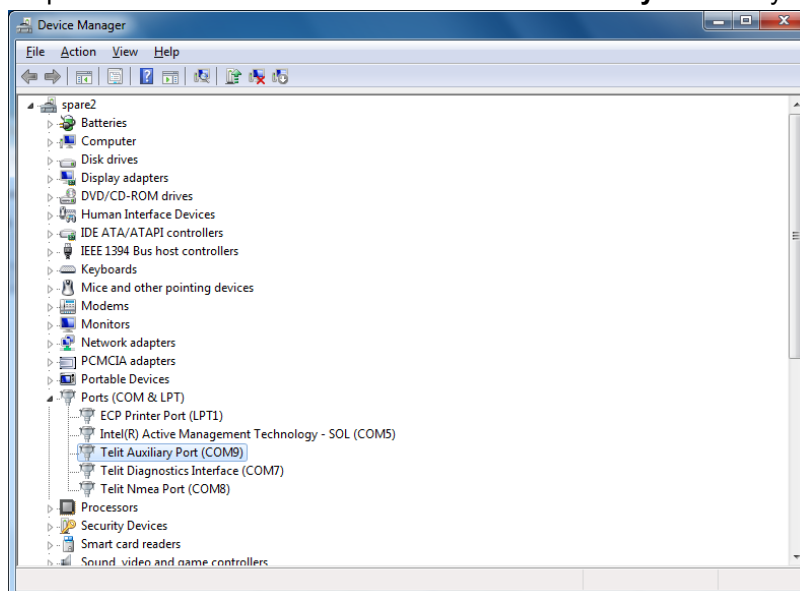

4. Start your terminal emulator program and select the Telit Auxiliary Port.

In this example the Port is COM9.

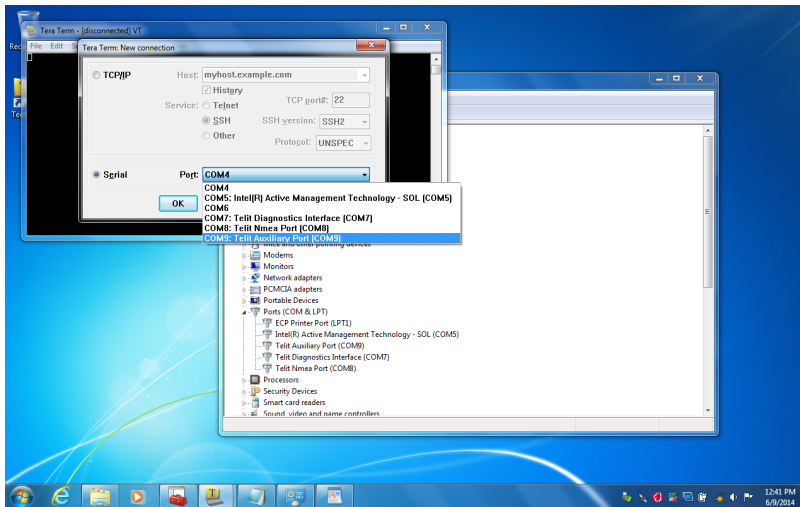

5. Once connected to the Auxiliary Port, provision the ReliaCELL 10-20-30 as follows:
 - a. Type `<AT>` `<Enter>` to verify the communication with the modem. The modem should return with `<OK>`.
 - b. Type `<AT+CREG?>` `<Enter>` to determine if the modem can see a home network tower. Confirm that the response is `+CREG: 0, 1`.



Important! If you receive a response of `+CREG: 0, 5`, the modem cannot see your carrier's home network and is roaming (using another carrier's tower and network). Do not proceed further. Try provisioning at a different location that can connect to one of your carrier's own cellular towers.

- c. Type `<ATD*22899;>` then press `<Enter>`. After several seconds you should see the four response lines as shown below. If you do not see all three `#OTASP` lines, then either you do not have a good connection through your antenna to the nearest cellular tower, or the carrier activation has not been completed.

```

at
OK

ATD*22899;
OK

#OTASP: 0
#OTASP: 1
#OTASP: 2
NO CARRIER
  
```

6. Disconnect the SUB cable from the modem for one to three minutes, then reconnect. Your ReliaCELL 10-20-30 modem is now ready for cellular communication.

Connect the ReliaCELL 10-20 to the Internet

Your ReliaCELL 10-20 must be provisioned and activated before performing these steps.

Connect the ReliaCELL 10-20 to the PC

Connect the USB extension cable between the ReliaCELL 10-20 and the PC.

Disconnect Other Network Adapters

During testing, disconnect other active network adapters to route all traffic through the ReliaCELL 10-20. You will re-enable them at the end of testing:

1. Select Start > Control Panel > Network and Internet > Network and Sharing Center > View Your Active Networks > Connect or Disconnect
2. Highlight any active Network connections.
3. Click "Disconnect."

Create a Windows Dial-Up Connection

1. Select Start > Control Panel > Network and Sharing Center > Set Up a New Connection or Network > Connect To the Internet
2. Set Up a New Connection Anyway > select Dial-Up
3. Enter the model and carrier-specific connection dial-up phone number:

Connection Name	Dial-up Phone Number
ReliaCELL 10-20-30 (Verizon CDMA)	#777

Test the ReliaCELL 10-20

1. Click Start > Control Panel > Network and Sharing Center > View Your Active Networks > Connect or Disconnect
2. Select the "ReliaCELL 10-20-30" Dial-up connection and Click "Connect".
3. A "Registering..." message will appear and last about a minute while the modem registers on the network.
4. From the Windows command line (Start > <cmd><Enter>), type the following commands:

```
ping google.com
tracert google.com
```
5. The trace-route will likely show cellular-carrier-specific domains in the early portions of the trace.
 E.g. myvzw.com for Verizon.



WARNING!
 Select the tools you use to connect to the Internet with care.
 Web browsing can potentially consume monthly M2M data plans in minutes.

6. To see the amount of data used in the current session:
 Select Start > Control Panel > Network and Sharing Center > Change Adapter Settings > (click Telit adapter) > Status

Disconnect the ReliaCELL 10-20

Unplug the ReliaCELL 10-20 from the host computer to disconnect it from the network and prevent inadvertent use.

Re-Enable Other Network Adapters

For each of the network adapters you disabled previously, do the following:

1. Select Start > Control Panel > Network and Internet > Network and Sharing Center > View Your Active Networks > Connect or Disconnect
2. Right click an active Network connection.
3. Click "Connect."

Appendix C: Connecting with Linux

There are many Linux distributions. These instructions detail how to use the ReliaCELL 10-20 with Wind River Linux as installed on many of Eurotech's gateway products.

Utilizing the Generic *option* Driver

Linux includes a generic USB driver for GSM/CDMA modems called *option*. (This driver is named "option" because the most common device it's used for is/was a PC-Card made by Option Inc.)

Most recent Linux distributions do not require any user action in order to load this driver: it is enough to simply plug the USB cable.

Depending on your model and kernel version, it may be necessary to modify the driver source code and recompile the driver to add the modem id used in your ReliaCELL. This step is less likely with more recent kernel versions. For example, models using a Telit DE910 are supported in linux 3.4 and later. You can check your kernel version the with:

```
uname -a
```

command.

To check if the modem is recognized by the operating system, first type:

```
ls -l /dev/serial/by-id/
```

Then plug in the modem, wait a few seconds, and enter the above command again.

If the modem is recognized, new devices named /ttyUSBx will be created.

Example:

```
usb-Telit_Wireless_Solutions_Telit_HS-USB_Modem-if00-port0 -> ../../ttyUSB6
usb-Telit_Wireless_Solutions_Telit_HS-USB_Modem-if01-port0 -> ../../ttyUSB7
usb-Telit_Wireless_Solutions_Telit_HS-USB_Modem-if02-port0 -> ../../ttyUSB8
usb-Telit_Wireless_Solutions_Telit_HS-USB_Modem-if03-port0 -> ../../ttyUSB9
```

To determine which model modem you have type:

```
lsusb -d 1bc7:
```

The following output shows the Telit DE910 which is CDMA:

```
Bus 001 Device 006: ID 1bc7:1010 Telit Wireless Solutions DE910-DUAL
```

The DE910-DUAL presents the following devices if no other USB devices were previously connected:

```
DE910-DUAL      ttyUSB0      Diagnostic port
                ttyUSB1      NMEA port
                ttyUSB2      Auxiliary port
                ttyUSB3      Modem port
```

(Note: AT commands are allowed on Modem and Auxiliary ports)

If no devices are created in your system check for the existence of the kernel module:

```
lsmod | grep option
```

If no entries are found, load the kernel module, with root privileges:

```
modprobe option
```

If an error response is returned, (example: # FATAL: Module option not found) or the devices are still not created, this means that the kernel module is either not present in your system or does not contain the correct definition and it should be built. Refer to Section 2 for generic instructions.

If the devices are found, you will now need to provision your unit.

Provisioning the ReliaCELL 10-20

The following example pertains to the ReliaCELL 10-20-30 on the North American Verizon CDMA network.

Connect the supplied antenna

To provision the unit, use the following for an executable.

(Where ttyUSB2 is the Auxiliary Port)

```
Example: provision_cell
```

```
#!/bin/bash
```

```
device="/dev/ttyUSB2"
```

```
chat -V -s '' 'AT' 'OK' '' > $device < $device
chat -V -s '' 'AT#MEID?' 'OK' '' > $device < $device
chat -V -s '' 'AT+CMEE=2' 'OK' '' > $device < $device
chat -V -s '' 'AT+CSQ' 'OK' '' > $device < $device
chat -V -s '' 'AT+CREG?' 'OK' '' > $device < $device
chat -V -s '' 'ATD*22899;' 'OK' '' > $device < $device
```

```
cat < $device &
```

Type the following to make it executable:

```
chmod +x provision_cell
```

To run the file, type:

```
./provision_cell
```

The output of the last command should be:

```
#OTASP: 0
```

```
#OTASP: 1
```

```
#OTASP: 2
```

NO CARRIER

Wait approximately 30secs before going to the next step.

Next you will need to create a connection manager to connect/disconnect to a network.

Creating a Connection Manager

The three files you need for this type will be:

```
cdma_connect
cdma_disconnect
cdma_peer_script
```

Files should have the following code and all three files should be in the directory /etc/ppp/peers directory.

cdma_connect

```
# Connect to the network

ABORT "BUSY"
ABORT "VOICE"
ABORT "NO CARRIER"
ABORT "NO DIALTONE"
ABORT "NO DIAL TONE"
ABORT "ERROR"
"" "+++ath"
OK "AT"
OK "ATE1V1&F&D2&C1&C2S0=0"
OK "ATE1V1"
OK "ATS7=60"
OK "\d\d\d"
"" "atd#777"
CONNECT "\c"
```

cdma_disconnect

```
# Disconnect from the network

ABORT "NO CARRIER"
ABORT "BUSY"
ABORT "VOICE"
ABORT "NO DIALTONE"
ABORT "NO DIAL TONE"
"" BREAK
"" "+++ATH"
'' AT OK-+++ \c-OK-+++ \c-OK ATH OK ''
```

cdma_peer_script

```
921600
unit 0
logfile /var/log/cdma_test
debug
```

```
connect 'chat -v -f /etc/ppp/peers/cdma_connect'
disconnect 'chat -v -f /etc/ppp/peers/cdma_disconnect'
crtstcts
lock
noauth
defaultroute
usepeerdns
connect-delay 10000
```

The peer script should also be executable, to do this type the following in the directory with the files:

```
chmod +x cdma_peer_script
```

To connect to the network, you then call the script by typing:

```
pppd /dev/ttyUSB3 call cdma_peer_script
```

(Where ttyUSB3 is the modem port)

To disconnect from the network, you should kill the pppd process by typing:

```
killall pppd
```

Using GPS

To enable GPS, use the following for an executable.

(Where ttyUSB2 is the Auxiliary Port)

Example: enable_gps

```
#!/bin/bash
```

```
device="/dev/ttyUSB2"
```

```
reply=$(chat -V -s '' 'AT$GPSLOCK?' 'OK' '' > $device < $device) 2>&1))
```

```
if [ ${reply[2]} -ne 0 ]; then
```

```
echo "GPS is locked, will try to unlock it"
```

```
reply=$(chat -V -s '' 'AT$GPSLOCK=0' 'OK' '' > $device < $device) 2>&1))
```

```
else
```

```
echo "GPS is Unlocked"
```

```
fi
```

```
chat -V -s '' 'AT$GPSNMUN=1,0,0,0,0,0,0' 'OK' '' > $device < $device
```

```
chat -V -s '' 'AT$GPSP=1' 'OK' '' > $device < $device
```

```
chat -V -s '' 'AT$GPSNMUN=1,0,0,1,1,0,0' 'OK' '' > $device < $device
```

```
chmod +x enable_gps
```

```
./enable_gps
```

To read the GPS data from the command line:

```
stty -F /dev/ttyUSB1 9600
grep --max-count=10 . /dev/ttyUSB1
```

(where ttyUSB1 is the NMEA port)

Building the Driver

If the modem is not recognized by the system it is possible that the driver must be modified to recognize the modem.

Retrieve the appropriate kernel source code version for your system (preferably with the distribution package system, if any) and unpack/install it. From the unpacking root directory open the file:

```
/drivers/usb/serial/option.c
```

Note: If you cannot find the correct path for the file, type:

```
find / -name option.c
```

(If your system reports multiple paths, use the `uname -r` command to figure out which path you are currently using)

Check for the existence of the proper `#define` statement related to your module, according to the following table:

```
DE910-DUAL #define TELIT_PRODUCT_DE910_DUAL 0x1010
CE910-DUAL #define TELIT_PRODUCT_CE910_DUAL 0x1011
```

If not present, add the statement.

Then add the proper line in the `usb_device_id option_ids[]` structure:, according to the following table:

```
DE910-DUAL { USB_DEVICE(TELIT_VENDOR_ID, TELIT_PRODUCT_DE910_DUAL) },
CE910-DUAL { USB_DEVICE(TELIT_VENDOR_ID, TELIT_PRODUCT_CE910_DUAL) },
```

Save the changes and close the file.

-- Compiling the driver --

From the unpacking root directory of your kernel type:

```
make menuconfig
```

Configure the kernel according to the considered system configuration; then browse through the menus

```
Device Driver -> USB Support -> USB Serial Converter support
```

and choose to build

USB driver for GSM and CDMA modems
as a module.

Once configured, start the build by typing:

```
make
```

The kernel module `option.ko` can be found in the directory `drivers/usb/serial`.

If the kernel has been previously already built, the module can be compiled simply typing:

```
make M=drivers/usb/serial
```

The module can then be loaded using `modprobe` or `insmod`.

Appendix D: ReliaCELL 10-20 Models

Identification

Each ReliaCELL 10-20 is labelled with its serial number, MEID/IMEI, configuration, and BOM number.

The configuration number is the ordering part number. It is in the format,

930128-9nnnRr,

where

"nnn" is the product model and

"r" is the revision level.

The related 630128-9nnnRr number tracks changes to the components used to build the ReliaCELL 10-20.

ReliaCELL 10-20 Feature Matrix

The following are the ReliaCELL 10-20-xx models and the technologies they support:

ReliaCELL	Ordering #	Cellular Technology	Carrier	GPS+ Glonass	DIV
10-20-30	930128-9020R	3G Dual-band, CDMA/EVDO Rev A/1xRTT,	North America	Verizon	<input checked="" type="checkbox"/>
10-20-32	900128-9010R	3G Dual-band CDMA/EVDO Rev A/1xRTT	North America	Sprint	<input checked="" type="checkbox"/>
10-20-34	900128-9030R	3G Penta-band HSPA+, Quad-band GSM/EDGE dual SIM	Europe	AT&T, T-Mobile, Rogers, Bell, et al	<input checked="" type="checkbox"/>
10-20-36	900128-9033R	3G Penta-band HSPA+, Quad-band GSM/EDGE, dual SIM	South Korea	SKT	<input checked="" type="checkbox"/>
10-20-37	900128-9032R	3G Penta-band HSPA+, Quad-band GSM/EDGE, dual SIM	Japan	NTT DOCOMO	<input checked="" type="checkbox"/>
10-20-20	900128-9031R	2G Quad-band GSM/GPRS, dual SIM	Europe	<input checked="" type="checkbox"/>	
10-20-25	900128-9021R	2.5G dual-band CDMA/1xRTT	North America	Verizon	
10-20-26	900128-9011R	2.5G dual-band CDMA/1xRTT	North America	Sprint	

Revision History

The following is an overview of the product revision history of the ReliaCELL 10-20.

Revision A

Production release

Appendix E: Modem Commands

The following are typical commands used to determine status of the modem and cellular connection:

Description	AT Command	Modem Response (Examples)	Notes
Verify Communication with Modem	AT	OK	
Display MEID #	AT#MEID?	#MEID: A10000,FEDCBA98	When printing or otherwise sharing the MEID, omit the comma.
Check Signal Quality	AT+CSQ=	+CSQ: 22,99	0-31, where 0 is -113dB and 31 is -51dB or stronger. Values higher than 19 (-75dB) will hold a connection reliably. Use the first number "x" to calculate signal strength: $\text{dBm} = (-113) + (2 * x)$
Check Phone Number	AT\$MDN?	\$MDN: 3015551212	The phone number issued during activation will be listed here.
Read Modem Firmware Revision	AT+GMR	15.00.024	This is the revision used for Verizon 3G ReliaCELL 10-20 units
Read Network Registration Report	AT+CREG?	+CREG: 0,1	0, 0 Searching 0, 1 Connected 0, 2 Failed 0, 3 Denied 0, 5 Connected roaming

WORLD SUPPORT

EUROTECH

Via Fratelli Solari, 3/a
33020 Amaro (UD) – Italy
Tel: +39 0433.485.411
Fax: +39 0433.485.499
E-mail: support.it@eurotech.com
Web: www.eurotech.com

EUROPE

Tel: +39 0433.485.411
Fax: +39 0433.485.499
E-mail: sales.it@eurotech.com
E-mail: support.it@eurotech.com
Web: www.eurotech.com

UNITED KINGDOM

EUROTECH
Tel: +44 (0) 1223.403410
Fax: +44 (0) 1223.410457
E-mail: sales.uk@eurotech.com
E-mail: support.uk@eurotech.com
Web: www.eurotech.com

FRANCE

EUROTECH
Tel: +33 04.72.89.00.90
Fax: +33 04.78.70.08.24
E-mail: sales.fr@eurotech.com
E-mail: support.fr@eurotech.com
Web: www.eurotech.com

AMERICAS

Toll free: +1 888.941.2224
Tel: +1 301.490.4007
Fax: +1 301.490.4582
E-mail: sales.us@eurotech.com
E-mail: support.us@eurotech.com
Web: www.eurotech-inc.com

ASIA

Tel: +81 86.245.2861
Fax: +81 86.245.2860
E-mail: sales@advanet.jp
E-mail: tsupport@advanet.jp
Web: www.advanet.jp

INDIA

EUROTECH
Tel: +91 80.43.35.71.17
E-mail: sales.in@eurotech.com
E-mail: support.in@eurotech.com
Web: www.eurotech.com

For your local contact please refer to: www.eurotech.com/contacts